

Operating Instructions

# MAVO-SPOT 2 USB

Digital Luminance Meter with 1° Measuring Angle

**GOSSEN**

15365

3/04.19





Thank you for buying the precise **MAVO-SPOT 2 USB** from GOSSEN. Your new luminance meter guarantees the reliable measurement of daylight and artificial sources of light including LED.

The high precision luminance meter for distance measurement with an acceptance angle of  $1^\circ$  is assigned to class B in accordance with DIN 5032-7, appendix B of DIN EN 13032-1 and CIE 69. It measures the perceived brightness of back-lighted surfaces in candelas per square meter ( $\text{cd/m}^2$ ) or foot-lambert (fL) in consideration of ambient light.

The meter is equipped with an excellent adaptation to the spectral brightness sensitivity of the human eye  $V(\lambda)$  and is highly precise with a minimal deviation of just  $f1' < 3\%$ , which is significantly better than specified in the standard. By means of the mirror reflex optics, the measuring subject may be targeted precisely in a  $15^\circ$  field of view and a sharply marked  $1^\circ$  measuring circle in the center of the viewfinder. Focus can be set for distances ranging from 1 meter to infinity. Shorter distances as of 34 cm are made possible by means of optional close-up lenses. Alternatively, contact measurement can also be performed with an optional, top quality probe. The velvety coating on the adapter disc prevents scratching of self-luminous and back-lighted surfaces.

The comparative and ratio measurements are especially advantageous, by means of which deviation of measured value B from reference value A is evaluated and displayed. The relationship  $A/B$  is used for contrast measurement at work-stations. Percentage deviation  $\%A$  allows for an assessment of the consistency of monitor screens and projection screen lighting, and difference  $A-B$  is used to detect deviation during the production process.

The meter's continuous operating mode is assured thanks to power supply via the USB port. Meter control, as well as acquisition, display and storage of measured values, is managed with the free GLUX 2 software which can be downloaded from the GOSSEN website.



**Do not perform measurements with the instrument pointed towards sun. Eye damage may result, and the light sensor could be damaged as well.**

<b>Table of Contents</b>		<b>Page</b>
<b>1</b>	<b>Initial Startup</b>	<b>8</b>
1.1	Inserting the Batteries	8
	Self-Test	8
	Battery Indicator	8
1.2	Lens Accessories	9
1.3	Changing the Default Settings	9
	Modes: Standard and Compact	9
	Unit of Measure, cd/m <sup>2</sup> or fL	10
	Memory Display: Individual or Groups	10
<b>2</b>	<b>The Meter and its Controls</b>	<b>11</b>
2.1	Device Overview	11
2.2	Display	12
2.3	Controls	13
<b>3</b>	<b>Operation</b>	<b>13</b>
3.1	Switching the Instrument on	13
3.1.1	Display On-Time	13
3.2	Measurements	14
3.2.1	Overflow / Underflow Display	14
3.3	Reference Quantity Measurement	15
3.3.1	Ratio A/B	16
3.3.2	Percentage Deviation %A	17
3.3.3	Difference A-B	18
3.4	Setting Correction Factors	20

<b>Table of Contents</b>		<b>Page</b>
3.5	Memory Function	23
3.5.1	Saving Measured Values	23
3.5.2	Editing Measured Values	24
3.5.3	Saving Values with Corr. Factor	25
3.5.4	Reading Out Measured Values	25
3.5.5	Clearing Memory	25
3.5.6	Saving Measured Values (in groups)	26
<b>4</b>	<b>Additional Applications</b>	<b>27</b>
4.1	Contact Measurement	27
4.2	Near Range Measurement	27
4.3	Stationary Use	27
4.4	Illuminance Measurement	28
<b>5</b>	<b>USB Port - Software</b>	<b>28</b>
	GLUX 2 Software	28
	Interface Description	28
<b>6</b>	<b>Factory Calibration</b>	<b>29</b>
<b>7</b>	<b>Practical Tips</b>	<b>29</b>
<b>8</b>	<b>Service Notes</b>	<b>30</b>
<b>9</b>	<b>Technical Data</b>	<b>31</b>
	<b>Declaration of Conformity</b>	<b>34</b>

## Safety Precautions

Please read these safety precautions carefully before using your meter. This will help you to avoid damaging the product and prevent personal injury.



This symbol identifies important warnings which should be read in any case before initial startup of your GOSSEN product.

## Warnings



**In the event of malfunctioning, switch the meter off immediately.**

In the event that smoke develops or unusual odors become apparent, which are caused by the meter, remove the batteries from the device in order to prevent possible fire. Continuing to operate the meter after such malfunctions have occurred may result in severe injury. Please contact your local dealer or **GOSSEN** Service in order to eliminate malfunctioning. If you bring or send the meter in for repairs, make sure that the rechargeable battery has first been removed.



**Do not use the meter in proximity to flammable gases.**

Electronic devices should never be used in proximity to flammable gases. Danger of explosion and fire is otherwise immanent.



**Never hang the device from children with the carrying strap.**

Danger of strangulation exists if the carrying strap is hung around the neck of a child.



**Store the meter at a location which cannot be accessed by children.**

The meter and its accessories include parts which can be swallowed. Make sure that these parts (e.g. housing covers, batteries etc.) do not fall into the hands of children who might swallow them. Otherwise, danger of suffocation prevails.



**Use suitable cables only.**

Use included, original **GOSSEN** cables only for connection to external devices. **GOSSEN** assumes no liability if other cables are used.

**Do not dismantle the meter.**

Never touch any parts inside the housing. Injury may result. Do not repair the meter yourself. Repairs may only be conducted by appropriately trained personnel. If the meter's housing is damaged due to dropping or other external influences, remove the batteries and contact your local dealer or **GOSSEN** Service for repair.

**Avoid any and all contact with the liquid crystals.**

If the display is damaged (e.g. broken), danger of injury due to contact with glass shards or discharge of liquid crystals exists. Make sure that skin, eyes and mouth do not come into contact with the liquid crystals.

**Be careful when handling batteries.**

Batteries may leak or explode if handled incorrectly. Please adhere to the following safety precautions:

- Make sure that the meter is switched off before removing or inserting batteries.
- Only use batteries which are recommended for this meter.
- Make sure that the batteries are correctly inserted.
- Never short-circuit batteries, and never attempt to open batteries.
- Do not expose batteries to excessive heat or open fire.
- Do not expose batteries to moisture and never immerse batteries in water.
- After removing the batteries from the meter, close the battery compartment with the lid (e.g. if the meter will not be used for a lengthy period of time).
- Never store batteries together with metallic objects which might cause short-circuiting.
- Danger of leakage exists, especially in the case of empty batteries. In order to prevent damage to the meter, batteries should be removed when fully depleted or in the case of lengthy periods of non-use.
- When not in use, batteries should be stored in a cool place.
- Batteries heat up during use and may become hot. Be careful not to burn yourself when removing batteries. Switch the meter off or wait until it has shut itself down, and then wait a bit longer until the batteries have cooled down.
- Do not use batteries which show any signs of damage such as discoloration or deformation of the housing.

## Other Notes

- Reproduction of product documentation or duplication of any excerpts therefrom necessitates the express consent of **GOSEN** Foto- und Lichtmesstechnik GmbH. This applies as well to duplication in any electronic format and translation into other languages.
- **GOSEN** Foto- und Lichtmesstechnik GmbH reserves the right to make changes of any type without providing advanced notice.
- **GOSEN** assumes no liability for damages resulting from incorrect use of the product.
- Documentation for your **GOSEN** meter was prepared with the greatest of care. If you should nevertheless discover errors, or if you would like to suggest any improvements, **GOSEN** would be very pleased to hear from you.

## Symbol for separate collection of recyclable materials / hazardous waste in European countries



This symbol indicates that this product must be disposed of separately.

The following must be observed by users in European countries:

- This product may only be disposed of separately at a designated collection point. It may not be disposed of with household trash.
- For further information contact your local dealer or waste disposal authorities.

# 1 Initial Startup

## 1.1 Inserting the Batteries

The battery compartment is located at the front of the grip. Push the battery compartment cover in the grip down. Remove the battery holder with the help of the tab. Replace the batteries assuring correct polarity (+ and -). Insert the battery holder into the instrument and close the battery compartment with its cover. Approximately 5000 measurements can be performed with a new set of batteries.

**Attention:** Use new batteries only in accordance with IEC LR6 (2 ea. 1.5 V, AA).





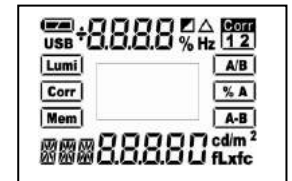

### Self-Test

After inserting the batteries, the microcomputer executes a self-test. All of the elements included in the display panel appear at the display during this test. The display test can be aborted by pressing any key.



### Battery Indicator

The MAVO-SPOT 2 requires two 1.5 V AA batteries (alkaline manganese). The capacity display  indicates the current battery power level. Measured values are retained in memory when the batteries are changed.

-  = The batteries are fully charged.
-  = The batteries are partially discharged – be prepared to replace them.
-  = The batteries are depleted and must be replaced as soon as possible.

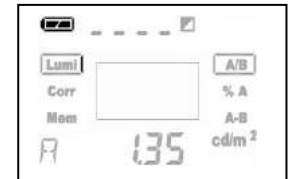



## 1.2 Lens Accessories

When using optional lens accessories, means close-up lenses or probe for contact measurement, only a maximum of one accessory may be mounted in front of the lens. The optional accessories for the meter are adapted to its specified accuracy. The use of accessories from other manufacturers may lead to significant measurement deviations in the range of several percent.

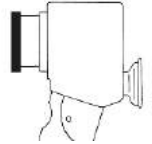

## 1.3 Changing the Default Settings

You can change the default settings for your MAVO-SPOT 2. The settings are selected with the help of the DIP switches inside the battery compartment underneath the battery holder. The default settings can be changed as desired in any combination.

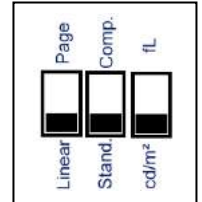

### Stand. - Comp. DIP switch – selection of standard or compact operating mode

The operating mode can be changed from standard to compact with the **Stand. - Comp. DIP switch**. You can perform measurements and save measured values in the compact mode – the calculation and correction values functions (Corr) are disabled; programmed correction values are nevertheless taken into account.

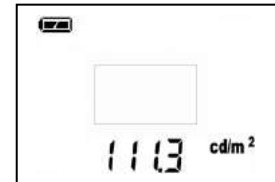
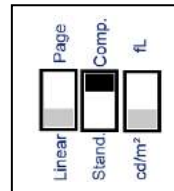
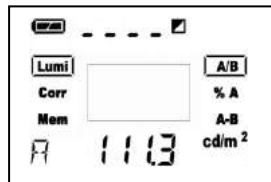
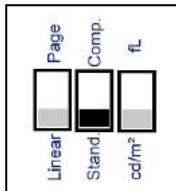

### cd/m<sup>2</sup> - fL DIP switch – selection of a of a unit of measure: cd/m<sup>2</sup> or fL

The desired unit of measure, namely candelas per square meter or foot-lamberts, can be selected with the **cd/m<sup>2</sup> - fL DIP switch**.



### Linear - Page DIP switch – selection of 1000 individual memory locations or subdivision into groups

You can select either consecutive storage of 1000 measured values or subdivision into 10 groups with 100 measured values each with the **Linear - Page DIP switch**. The pages are identified as P-01 through P-10.

**Memory content is deleted automatically when the memory location display mode is switched.**

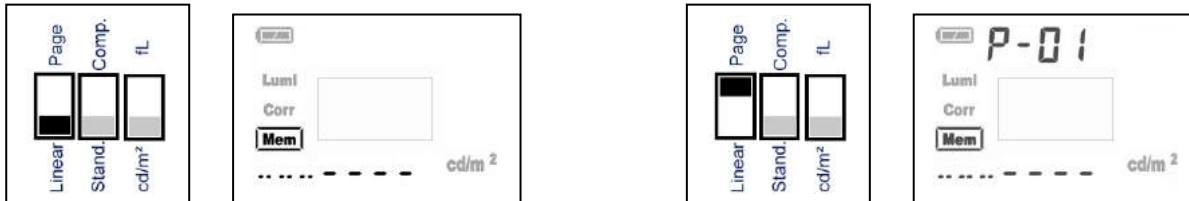

## 2 The meter and its Controls

### 2.1 Device Overview



## 2.2 Display

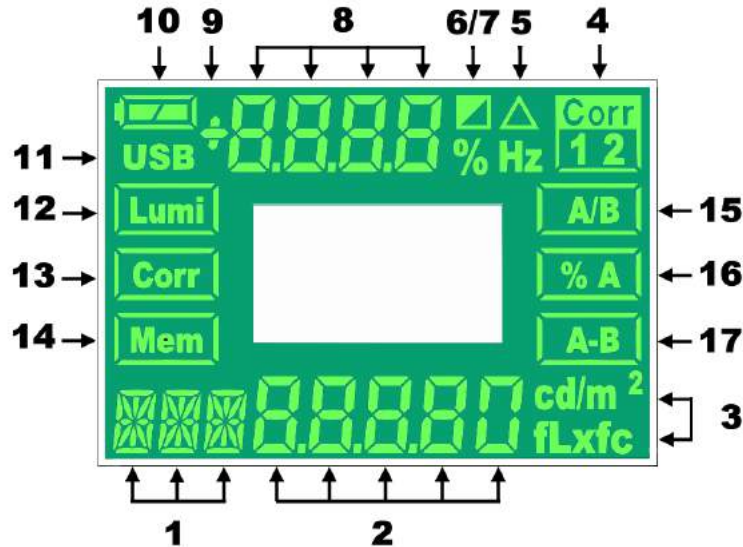

- 1 Memory location display
- 2 Measured value and memory display
- 3 Unit of measure
- 4 Symbol for correction factors 1 and 2
- 5 Difference symbol
- 6 Ratio symbol
- 7 Percentage deviation symbol
- 8 Calculated value, memory group
- 9 Plus or minus sign for calculated value
- 10 Low battery warning display
- 11 USB indicator
- 12 Measuring function
- 13 Correction factor function
- 14 Measured value memory function
- 15 Ratio function
- 16 Percentage deviation function
- 17 Difference function

## 2.3 Controls

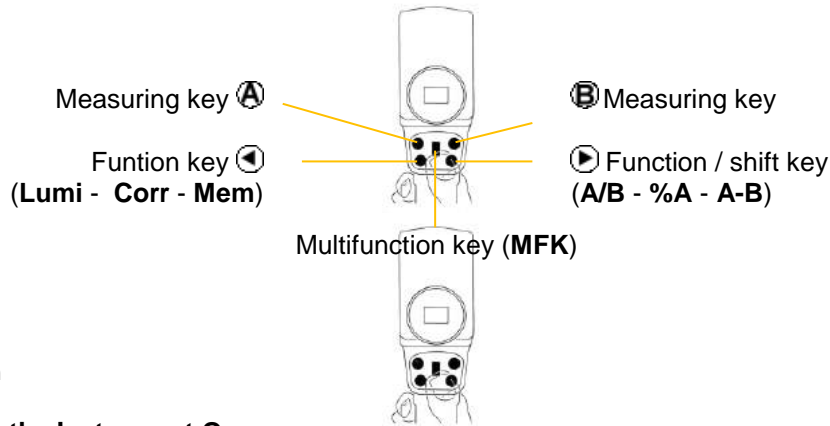

## 3 Operation

### 3.1 Switching the Instrument On

The MAVO-SPOT 2 can be switched on by pressing any key. The measuring instrument is activated and the display panel is illuminated. The last measured values appear at the display (display memory).



#### 3.1.1 Display On-Time

If none of the keys at the MAVO-SPOT 2 are activated for a period of 30 seconds, the instrument is switched off automatically, i.e. the display goes blank but measured values and individual settings are stored to memory.

## 3.2 Measurements

Press the  key to select the **Lumi** function.

Look through the eyepiece on the MAVO-SPOT 2, and sharply focus your measuring field with the focusing mechanism at the lens. Now align the measuring circle reflected into the viewfinder to the point to be measured. This point should be uniformly illuminated, and as large as possible relative to the measuring circle.

Press the  key and read the measured value.

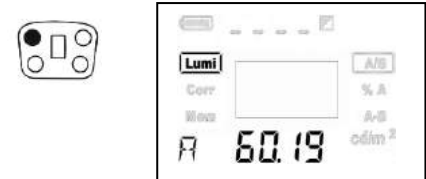
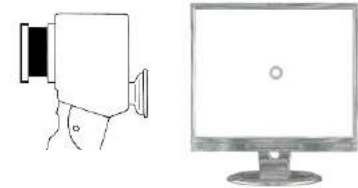

### 3.2.1 Overflow / Underflow Display

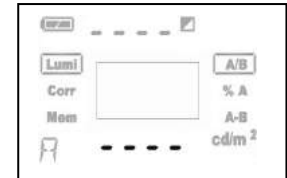

If the measuring range is exceeded, “----” appears at the display.

If the measuring range is fallen short of, “0.00” appears at the display.



### 3.3 Reference Quantity Measurement

You can compare two measured values with your MAVO-SPOT 2. Press the  key in order to select the **Lumi** function to this end.

- Acquire measured value A as described in section 3.2; measured value A is used as a reference value for the following functions.
- Press the  key in order to select the **A/B**, **%A** or **A-B** function.
- Now align the measuring circle to the second point.
- Press the  key; the calculated value for the respective function appears at the upper part of the display.

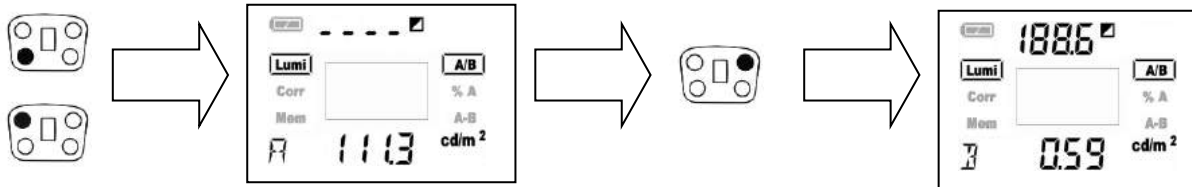

- After acquiring measured value B, calculated value **A/B**, **%A** or **A-B** can be displayed by pressing the  key.

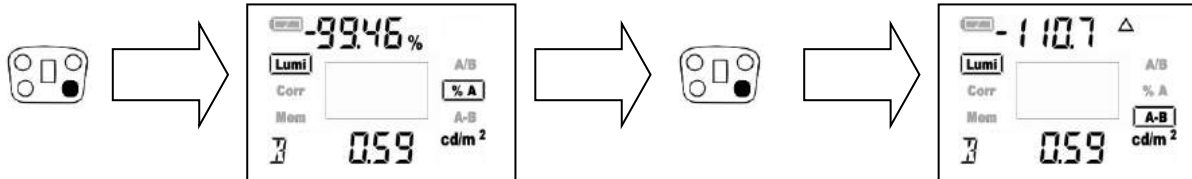

### 3.3.1 Ratio A/B

This function is used, for example, for contrast measurements and luminance distribution at workstations.

- The larger of the two measured values is always used as a dividend; i.e. if measured value B is larger than measured value A, the ratio of the two measured values is calculated as  $B \div A$ .

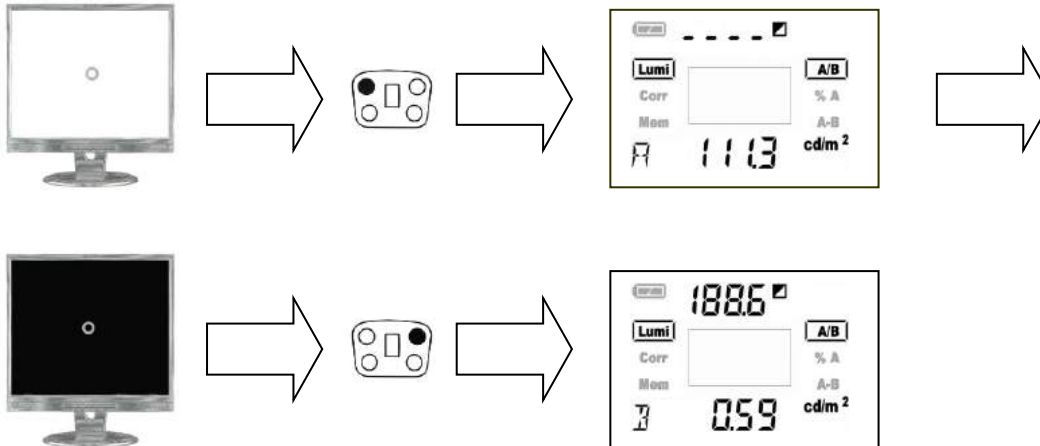



### 3.3.2 Percentage Deviation %A

This function is used, for example, for testing monitor screen uniformity (percentage deviation of screen corners from the reference value at the middle of the screen).

- Depending upon the respective results, the minus sign (-) must be observed.

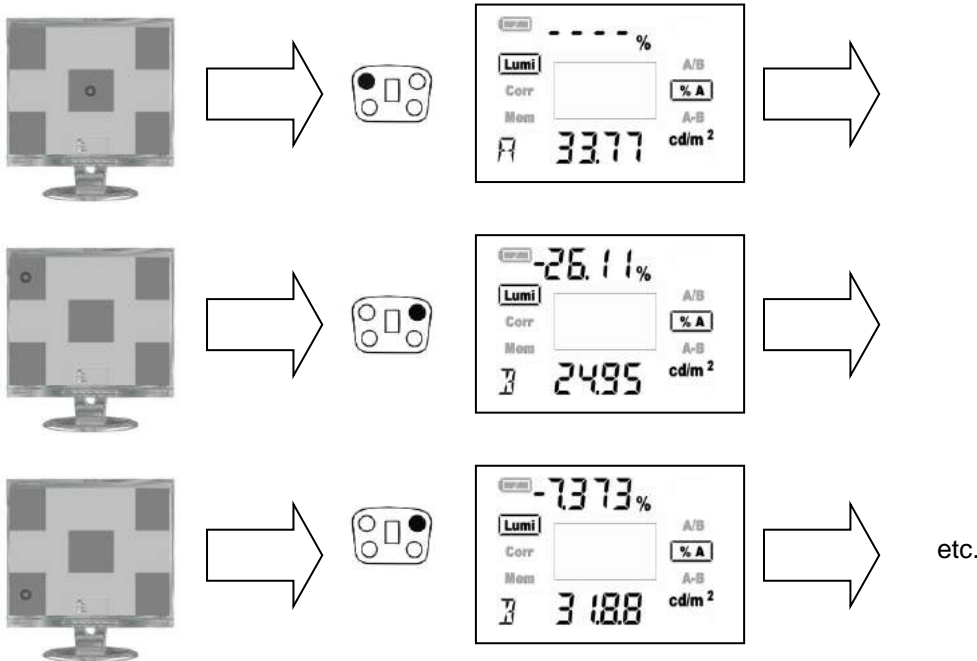

### 3.3.3 Difference A-B

You can read the difference between reference value A and the second measured value (B) directly from the display. This function is used, for example, for detecting deviations in manufacturing.

- Depending upon the respective results, the minus sign (-) must be observed.

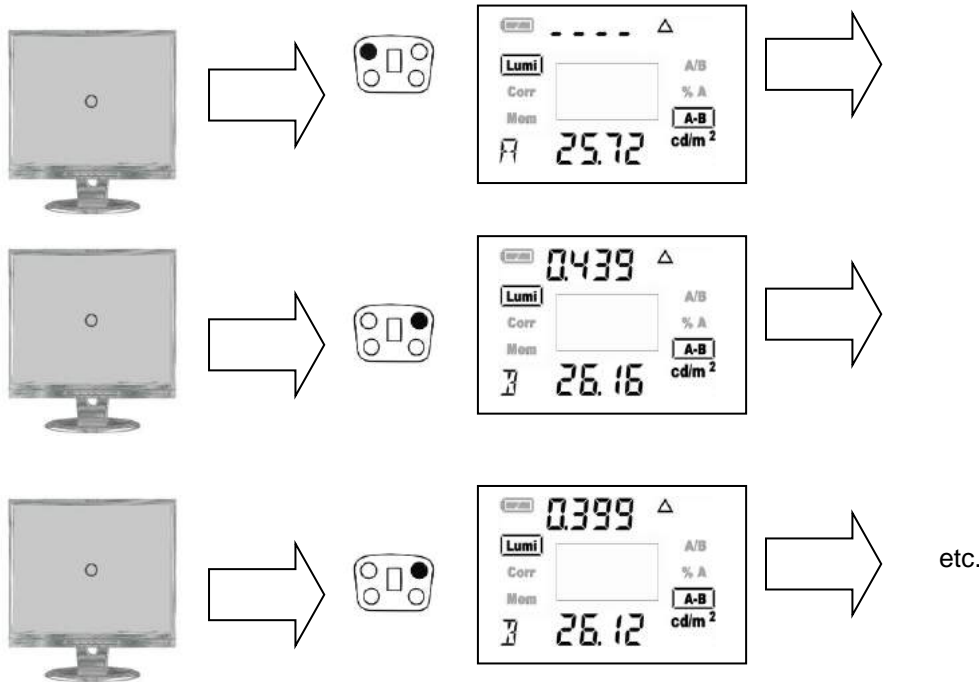

- You can switch back and forth between measured values A and B with the MFK.

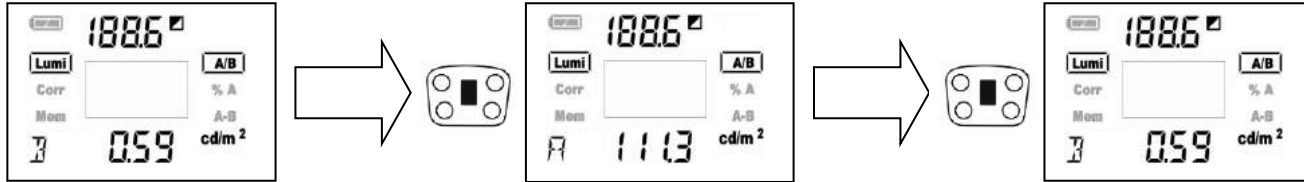

- The reflectivity of ceilings, walls and floors can be measured with the MAVO-SPOT 2 in combination with the **reflectance standard** (optional accessory). Estimations made with reflection or gloss panels are thus eliminated.
- The reference value is measured against the reflectance standard by pressing the **A** key in order to ascertain reflectivity.
- Further measurements executed with the **B** key indicate deviation as a percentage at the upper portion of the display.

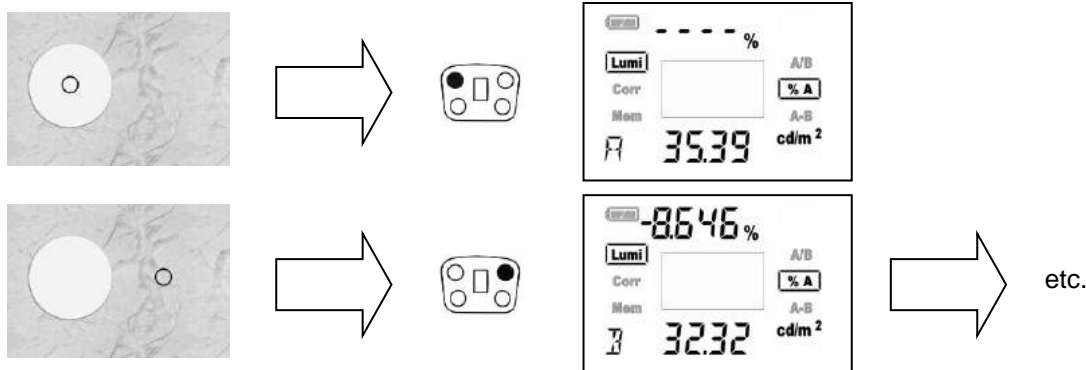

### 3.4 Setting Correction Factors

As many as two different correction factors can be entered to the MAVO-SPOT 2.

- As default values, Corr1 is set to a factor of 1.000 (no correction) and Corr2 to a factor of 3.142 (illuminance measurement with GOSSEN reflectance standard, optional accessory).

Press the  key to select the **Corr** function.

- Select the desired correction factor with the MFK (visible at the top of the display).
- While setting the factor, any measured value shown in the display is correspondingly adjusted (visible at the bottom of the display).

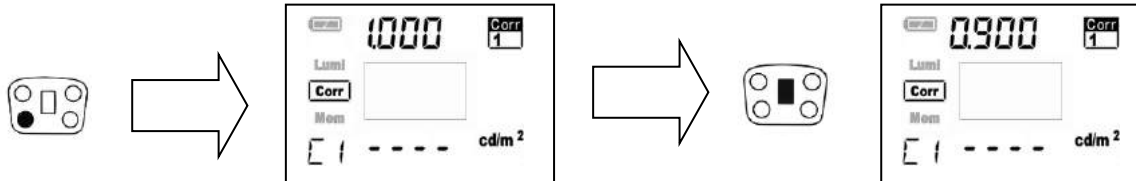

- You can switch back and forth between correction factors 1 and 2 with the  key.

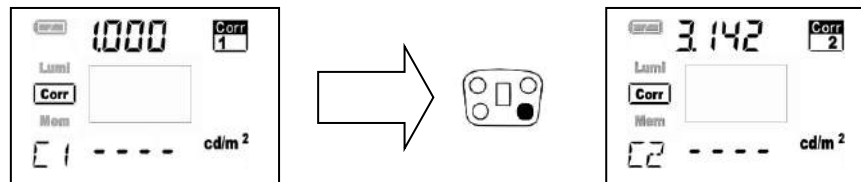

- With the **Corr2** function (factor of 3.142) and the **GOSSEN reflectance standard** (optional accessory), you can indirectly measure illuminance (lux or footcandles) with your MAVO-SPOT 2.
- The unit of measure is switched to illuminance (lx or fc) at the display while measurement is being performed.
- The factor 3.142 is the relationship between illuminance (E) and luminance (L) for a perfect reflecting diffuser

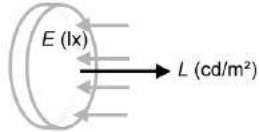

$$E = \pi * L$$

- **For a real diffuser (like GOSSEN reflectance standard) where reflectance is less than 100%, Corr2 must be adjusted to the actual value. Use the specific value delivered with your standards calibration protocol.**
- **You can't change Corr factors permanently until you have cleared the entire memory. This precaution is for preventing a mixup of measurements with different Corr factors in memory.**
- The individual factor is saved to correction memory by pressing the **Ⓢ** key.
- The correction factor is now applied to all measured values shown at the display, which can be saved to memory as well.
- The Corr symbol appears at the upper right hand corner of the display panel in order to indicate a programmed correction factor.

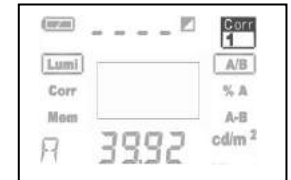

- Save Corr changes permanently

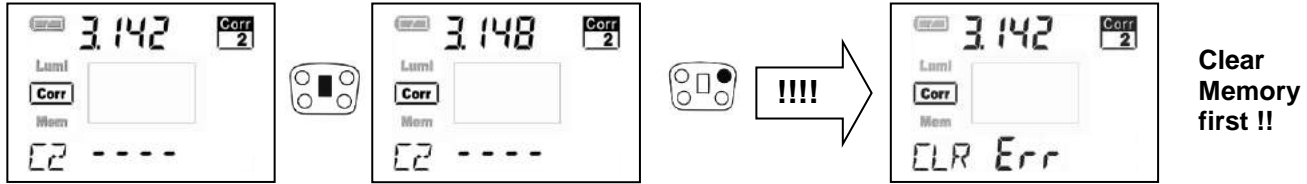

- Take readings with applied corr factors

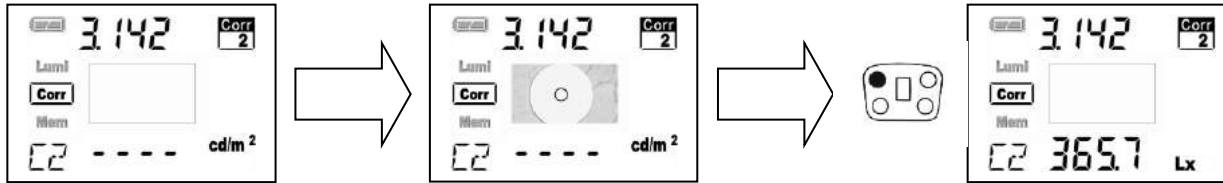

- Reset correction values to factory defaults by simultaneously pressing the **A** and **B** keys.

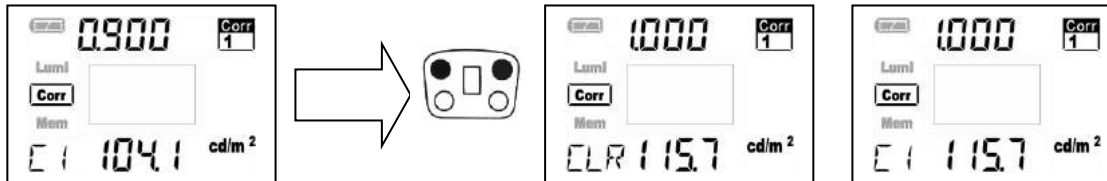

## 3.5 Memory Function

In addition to its display memory, the MAVO-SPOT 2 is also equipped with a measured value memory with 1000 memory locations. This function allows you to perform measurements on-site, and to read them out at a later point in time. Stored values are retained when the instrument is switched off, as well as when the batteries are replaced.

### 3.5.1 Saving Measured Values (basic function)

Press the  key to select the **Mem** function.

- Perform measurement as described in section 3.2.
- The displayed value is saved to memory by pressing the  key. STO (stored) appears briefly at the memory location display. In addition to the stored value, the number of the memory location is also displayed. Each additional stored value is saved to the next successive memory location and is assigned the next consecutive location number. FULL appears at the display when measured value memory is full. It is not possible to save a single measured value twice.

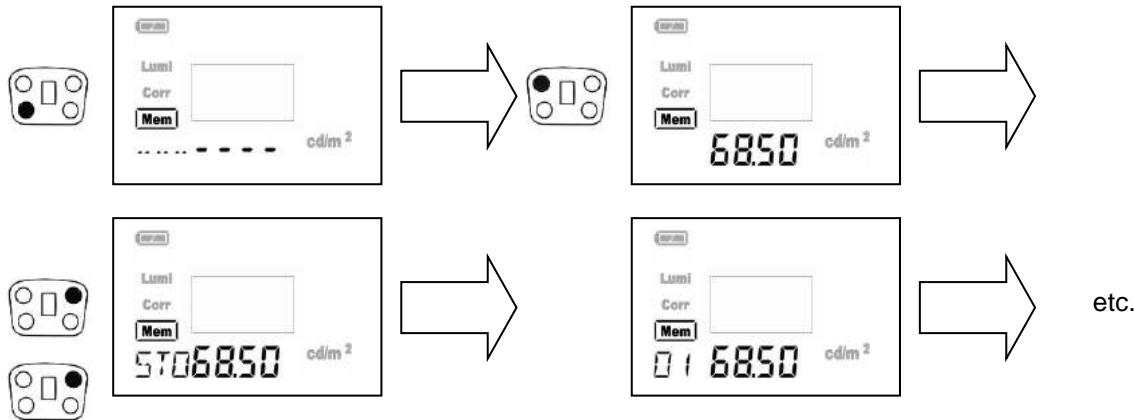

### 3.5.2 Editing Measured Values (Mem-Edit)

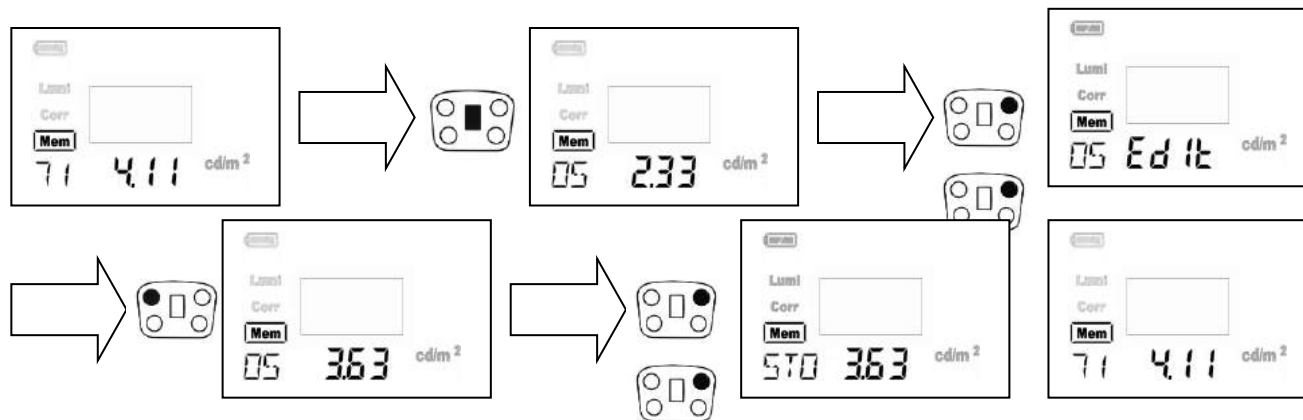

Stored measured values can be overwritten with the **Mem** function.

- Select the memory location to be edited with the MFK.
- Press the **B** key in order to freeze the memory location.  
“Edit” and the selected memory location is shown in the display indicating that you are up to overwrite the current mem-cell
- Acquire the new measured value as described in section 3.2.
- The displayed value is saved to memory by pressing the **B** key.
- The memory location display jumps to the last stored measured value.





### 3.5.3 Saving Measured Values with Correction Factor

If a correction factor has been programmed into the MAVO-SPOT 2 (see also page 17), a corresponding display appears automatically. You can now switch back and forth between Corr1 and Corr2 by pressing the  key. Corr2 (a factor of 3.142) is permanently programmed into the instrument – you can switch to illumination measurement with the GOSSEN reflectance standard (optional accessory) at any time by pressing the  key.

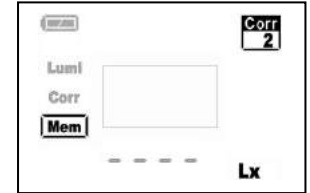



### 3.5.4 Reading Out Measured Values

With the **Mem** function, you can scroll through the measured value memory with the help of the MFK. Each respective stored value is displayed along with the memory location number. The longer the key is pressed and held, the faster the scroll speed becomes.



### 3.5.5 Clearing Memory

Measured value memory can be cleared with the **Mem** function.



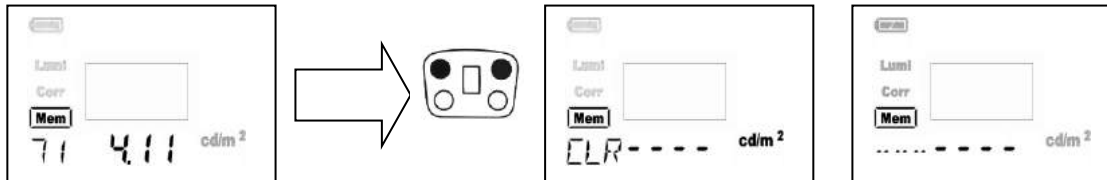

The entire measured value memory is cleared by simultaneously pressing and holding the  and  keys for at least 2 seconds. CLR appears at the display in order to acknowledge that memory has been cleared. “-----” appears once again at the memory location display.



### 3.5.6 Saving Measured Values (in groups)

Measured values can also be saved to 10 groups of 100 measuring locations each. This function is accessed by setting the “**Linear - Page**” DIP switch in the battery compartment to “Page”.

Press the  key to select the **Mem** function. The last used group appears at the display.

- Group selection can be accessed by simultaneously pressing the  and  keys.
- The last used memory group and the designations SEL und PAGE appear at the display.
- Select the group (P-01 through P-10) to which your measurements will be saved with the MFK.
- Group selection can be exited by simultaneously pressing the  and  keys.
- The other memory functions are used as described above.
- Measured values saved to the groups must be individually deleted.

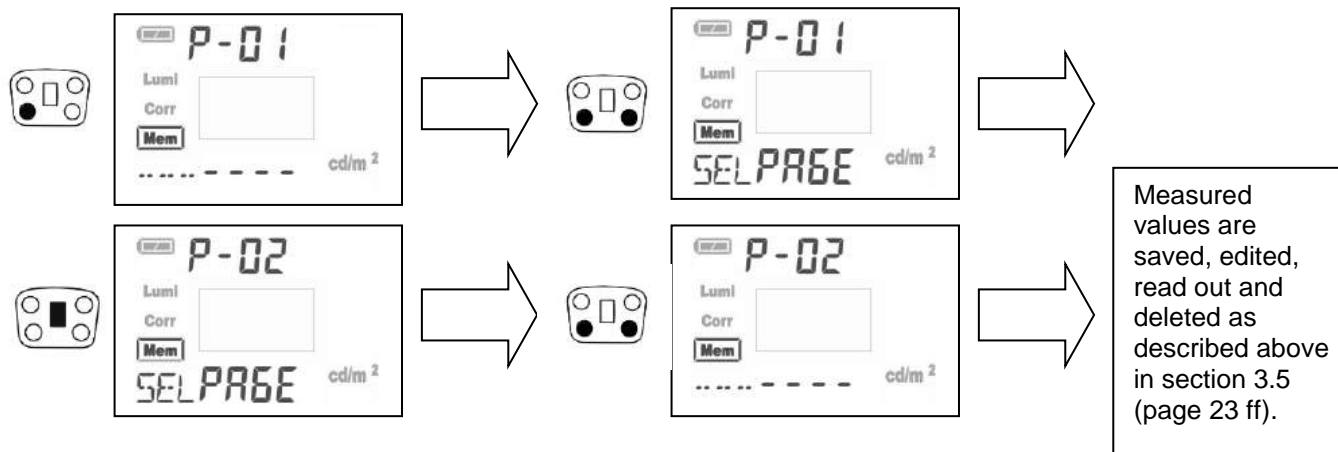

## 4 Additional Applications

### 4.1 Contact Measurement

The MAVO-SPOT 2 is designed for distance measurement. It can be placed directly onto a monitor screen or display surface with the optional probe for contact measurement which is delivered with an adapter disc. The pressure applied to flat screens or sensitive surfaces is significantly reduced thanks to the large surface area provided by the disc. The danger of damage during measurement is thus considerably reduced.



### 4.2 Near Range Measurement

Test points at distances ranging from 1 meter to infinity can be measured with the MAVO-SPOT 2. Two different close-up lenses are available for shorter distances. The measuring distance can be reduced by close-up lens 1 to the range of 51 cm to 1 m and with close-up lens 2 to the range of 34 cm to 50 cm. Please use only one close-up lens from the original accessories. Close-up lenses from other suppliers have almost a different transmission and this leads to reasonable measuring deviations of several percent.

### 4.3 Stationary Use

Your MAVO-SPOT 2 is equipped with a ¼" thread at the bottom for a tripod, and thus fits all commercially available tripod mounts. The protective cap must be attached to the eyepiece as well.

**Light which enters the MAVO-SPOT 2 via the eyepiece influences measurement results!**



## 4.4 Illuminance Measurement

The meter is designed for luminance measurement, but can also be used to measure illuminance in conjunction with the optional reflectance standard for illuminance measurement. The correction factor required for the conversion is stored in Corr2.

The display automatically switches to lx or fc when it is selected.

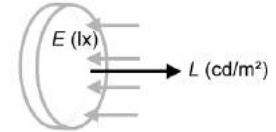

## 5 USB Port - Software

The USB interface of the meter is located on the front of the housing. The meter is connected to a PC via the USB interface cable. As long as the measuring device is connected to the PC, it is supplied via the USB interface and does not switch off.

### GLUX 2 Software

The intuitive GLUX 2 software is the link between the meter and customer-specific further processing at the PC. Momentary or stored measured values can be transmitted, saved as TXT files and read in by word processing, spreadsheet and database applications. The software and operating instructions can be downloaded from the MAVO-SPOT 2 product page at [www.gossen-photo.de](http://www.gossen-photo.de).

### Interface Description

The disclosed interface protocol for device control and data communication allows the integration into own applications. The interface description and associated demo applications are included in the above download of the GLUX 2 software.

## 6 Factory Calibration

The MAVO-SPOT 2 USB with intuitive user interface is an accurate and reliable luminance meter. Like all other precision light meters, this product also requires regular maintenance and recalibration in order to continuously fulfil performance capabilities within the tolerances and specifications stipulated by the manufacturer. Depending on conditions of use, a calibration interval of 12 to 24 months is recommended.



## 7 Practical Tips

A broad range of information regarding measured quantities, measuring methods, applications and photometry standards, as well as support in selecting a suitable meter, is included in the Photometry Compendium. It can be downloaded from the instrument product page at [www.gossen-photo.de](http://www.gossen-photo.de) under Downloads Catalogs or requested as a printed version from GOSSEN.

## 8 Service Notes

The instrument does not require any special maintenance if used in accordance with the operating instructions. If the instrument becomes contaminated during use, clean the surface of the housing with a slightly moistened cloth. If the optics or filter are contaminated, clean them with an optics cleaning cloth. Avoid the use of cleansers, abrasives or solvents.

- Do not touch the front lens!
- Use the instrument under normal ambient conditions. High atmospheric humidity and temperatures of greater than 55° C and less than -20° C should be avoided.
- When not in use, attach the lens cap to the front lens and store the MAVO-SPOT 2 in the included aluminum case.
- Do not expose your measuring instrument to excessive temperatures, for example in closed motor vehicles exposed to the sun, or near radiators and the like.
- Never point the front optics towards the sun.
- Do not expose the measuring instrument to strong impacts or vibration.
- Do not attempt to repair or tamper with the instrument. The MAVO-SPOT 2 can only be repaired by authorized GOSSEN service personnel.

If at any time your meter does not function to your full satisfaction, please contact us or send it to us at:

**GOSSEN Foto- und Lichtmesstechnik GmbH** | Lina-Ammon-Str.22 | D-90471 Nuremberg | Germany  
Phone: +49 911 800621 0 | e-mail: [info@gossen-photo.de](mailto:info@gossen-photo.de) | [www.gossen-photo.de](http://www.gossen-photo.de)

Customers outside of Germany are requested to contact their authorized dealer, whose address can be found on our website.

## 9 Technical Data

<b>Sensor Technology, Measuring Uncertainty</b>		
Type	High precision luminance meter for distance measurement with mirror reflex optic and viewfinder display for measuring light-source and surface brightness	
Classification	Class B per DIN 5032 part 7, DIN EN 13032-1 appendix B, CIE 69	
Measuring angle	1°	
Optical system	Field of view	15° diagonal
	Focal length	77 mm
	Aperture	f/1.8
	Flare factor	$f_2 < 2 \%$
	Focusing dist.	1 meter to infinity, with optional close-up lens starting from 34 cm
Measuring sensor	Silicon photodiode with optical $V(\lambda)$ filter	
Measuring uncertainty	$\pm 2,5 \%$ of reading $\pm 2$ digit	
<b>Photometry</b>		
Measuring method	Distance	Standard
	Contact	With optional probe for contact measurement
Measuring functions	Luminance	0.01 cd/m <sup>2</sup> ... 99,990 cd/m <sup>2</sup> / 0.01 fL ... 30,000 fL
	Illuminance	0.10 lx ... 99,990 lx
Measuring modes	Luminance	Standard measurement – A
		Contrast measurement – A/B
		Uniformity measurement - %A
		Difference measurement – A-B
Measuring units	cd/m <sup>2</sup> / fL – lx / fc (selectable, DIP switch)	
<b>Operation, Interfaces, Memory</b>		
Display	viewfinder with back-lit LCD, measured value display with 4-digit precision	
Controls	4 keys, 1 slide switch, 3 DIP switches in the battery compartment	
Interface	USB 2.0, data transmission, external power supply, open interface protocol	
Data storage	up to 1000 individual values or 10 groups with 100 individual values each (selectable, DIP switch)	
<b>Power Supply</b>		
Battery	2 ea. 1.5 V mignon batteries (IEC LR6, AA type)	
Automatic battery control	Multi-segment indicator	
Automatic shut down	30 sec	

Battery service life	Approx. 5000 measurements with alkaline batteries	
External power supply	USB, continuous operation	
<b>General</b>		
Dimensions	190 x 90 x 57 mm	
Weight	400 g (meter without batteries)	
Operating temperature	0 to +50° C	
Storage temperature	-20 to +70° C	
Tripod socket	¼"	
Scope of delivery	Meter, aluminum case, batteries, operating instructions D/GB, USB cable, protective lens cap, protective eyepiece cap, calibration protocol	
<b>Optional Accessories</b>		
Close-up lens 1 (51 cm ... 100 cm)	M496G	
Close-up lens 2 (34 cm ... 50 cm)	M497G	
Probe for contact measurement	M511G	
Reflectance standard for illuminance measurement	M512G	
Stray-light baffle	M513G	
Carrying strap	M514G	

### Most Important Error Limits DIN 5032-7 Class B

Characteristics	Admissible Error according to DIN 5032-7 class B	Typical Error MAVO-SPOT 2 USB
$V(\lambda)$ Adaptation - $f_1'$	6 %	≤ 3.0 %
Influence Environment Luminance - $f_2(u)$	2 %	≤ 1.5 %
Linearity - $f_3$	2 %	≤ 1.5 %
Temperature coefficient - $\alpha_0, \alpha_{25}$	1 % / K	≤ 0.5 % / K
Polarization - $f_8$	2 %	≤ 0.8 %



## V( $\lambda$ ) Adaptation - $f_1'$

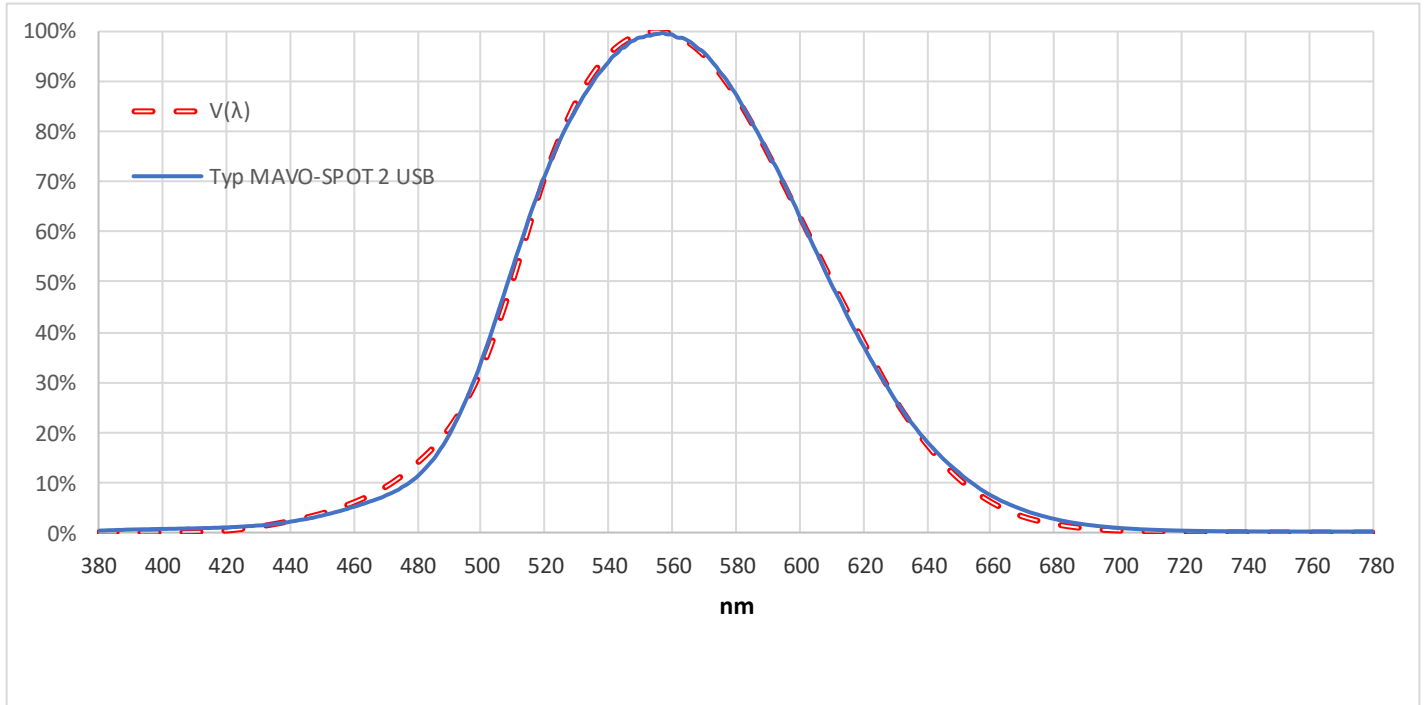



# EG - KONFORMITÄTSERKLÄRUNG - DECLARATION OF CONFORMITY

# GOSSEN

**Dokument-Nr. / Document.No.:** 107/2007  
**Hersteller/ Manufacturer:** GOSSEN Foto- und Lichtmesstechnik GmbH  
**Anschrift / Address:** Lina-Ammon-Str.22  
**90471 Nürnberg**

**Produktbezeichnung/ Product name:** Leuchtdichtemessgerät / Luminance Meter  
**Typ / Type:** MAVO-SPOT 2 USB  
**Bestell-Nr / Order No:** M508G

Das bezeichnete Produkt stimmt mit den Vorschriften folgender Europäischer Richtlinien überein, nachgewiesen durch die vollständige Einhaltung folgender Normen:  
 The above mentioned product has been manufactured according to the regulations of the following European directives proven through complete compliance with the following standards:

Nr. / No.	Richtlinie	Directive
2006/95/EG 2006/95/EC	Elektrische Betriebsmittel zur Verwendung innerhalb bestimmter Spannungsgrenzen - Niederspannungsrichtlinie - - Anbringung der CE-Kennzeichnung : 2008	Electrical equipment for use within certain voltage limits - Low Voltage Directive - Attachment of CE mark : 2008
<b><u>EN/Norm/Standard</u></b> EN 61010-1 : 2001	<b><u>IEC/Deutsche Norm</u></b> IEC 61010-1 : 2001	<b><u>VDE-Klassifikation/Classification</u></b> VDE 0411-1 : 2002
<b><u>Nr. / No.</u></b> 2004/108/EG 2004/108/EC	<b><u>Richtlinie</u></b> Elektromagnetische Verträglichkeit - EMV - Richtlinie	<b><u>Directive</u></b> Electromagnetic compatibility -EMC directive

Fachgrundform / Generic Standard: EN 61326 : 2006

Nürnberg, den 09.Januar 2008

Ort, Datum / Place, date:

Vorsitzender der Geschäftsführung

**Diese Erklärung bescheinigt die Übereinstimmung mit den genannten Richtlinien, beinhaltet jedoch keine Zusicherung von Eigenschaften. Die Sicherheitshinweise der mitgelieferten Produktdokumentationen sind zu beachten.**  
**This declaration certifies compliance with the above mentioned directives but does not include a property assurance.**  
**The safety notes given in the product documentations which are part of the supply, must be observed.**



---

Printed in Germany – Subject to change without notice

**GOSEN Foto- und Lichtmesstechnik GmbH** | Lina-Ammon-Str.22 | D-90471 Nuremberg | Germany  
Phone: +49 911 800621 0 | E-Mail: [info@gossen-photo.de](mailto:info@gossen-photo.de) | [www.gossen-photo.de](http://www.gossen-photo.de)