

**Before you start measuring**

- Get the film speed 3
- Test zero position 3
- Testing and replacing the battery 4

**The measurement method**

- Standard setting 5
- Extended measurement 7
- Modification of standard exposure 8
- Extension factors 9
- Exposure value modification 10
- Modification of exposure times 11
- Reading the scales 12
- Extreme film sensitivities 13

**Measuring continuous light**

- Measuring flashes 15
- Measuring range 16
- Measuring in extremely bright ambient continuous light 17
- Adding up multiple flashes 18

**Reflected light measurement – incident light measurement**

- Light intensities and luminance 19
- Measuring contrast 22
- Zone system 23
- Reciprocity effect 24
- The LUNASIX F system – attachments 25
- 26

# LUNASIX F

GOSSEN

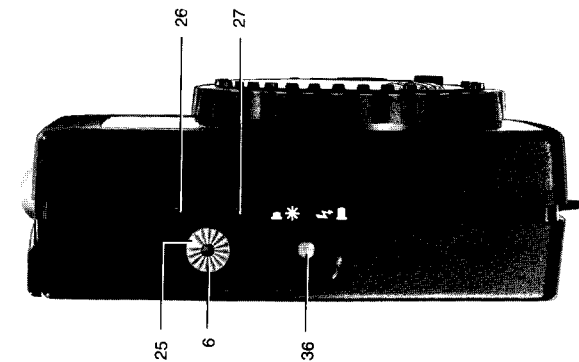
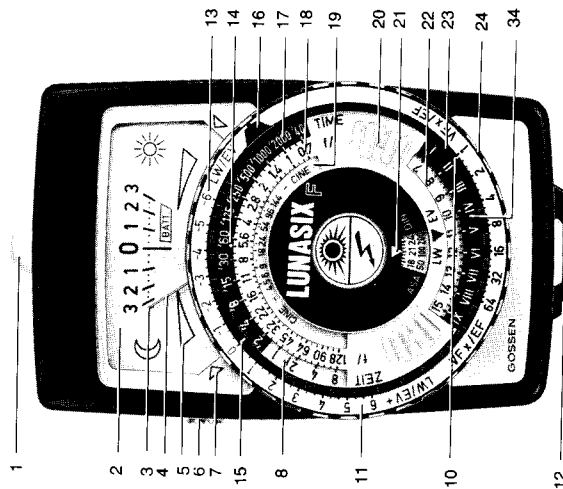

1	Spherical diffuser (for incident light measurement)	18	Aperture Scale (f-stops)
2	Indicator scale	19	Cine Scale (frames per second)
3	Zero adjustment line	20	Ribbed film speed setting disk
4	Indicator needle	21	Index for DIN/ASA setting
5	Rotation direction indicators	22	Exposure Value (EV) scale
6	Measuring button (red)	23	Setting ring for modified settings
7	Red triangles	24	Computer ring for setting indicator needle
8	Red arrow for flash readings	25	White selector index for measurement duration
9	Button for battery test (green)	26	Square setting mark for single measurement with storage
10	White index line for extension factor setting	27	Round setting mark for extended measurement cycle
11	Extension factors	28	Zero adjustment screw
12	Eyelet for neckstrap	29	Lux and Footcandle scale equivalents
13	EV (Exposure Value) modification scale (+ and -)	30	Battery chamber
14	Reading dot for cinematographers (1/50 sec)	31	Light entry aperture
15	(White index line for EV modification setting)	34	Division for zone system
16	Sliding black cover for red signal	36	Mode switch for continuous light or flash measurements
17	Exposure Time Scale		

# The LUNASIX F

is one of the high quality precision meters

## GOSSEN

is manufacturing for the light measuring technique.

Your LUNASIX F is a very valuable meter, precisely manufactured and accurately calibrated. The built-in silicon photo diode (silicon blue cell) achieves an instant measuring response, even at extremely low light levels. Its superior filtration results in a spectral sensitivity of outstanding character. The LUNASIX F will answer all questions which might arise concerning photographic exposure reliably and precisely. It will help you to determine the correct exposure data for photographs which will rank high above the average as to picture quality and creative composition. This instruction booklet will give you many valuable suggestions to assure you of getting consistently good results.

2

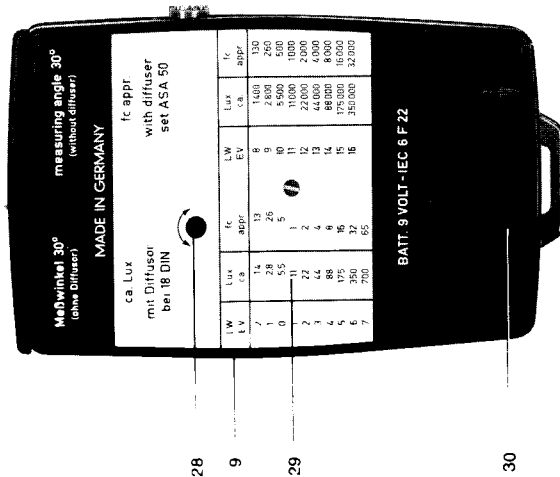

1

### Before you Start Measuring

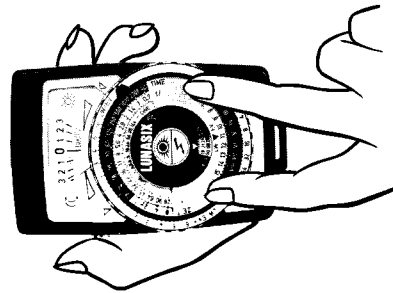

#### Set the Film Speed

Turn the film setting disk (20) by its ribs until the DIN/ASA index number of your film is lined up with the white triangle (21) above the DIN/ASA scale window.

Make sure the black cover (16) conceals the red signal; the white index line (15) must be at the red "0", and the opposite white index line (10) at "1" (Standard Setting). You can rotate the inner setting ring (23) by its raised cleats or by the black cover (16) to adjust the setting (see page 8).

#### Test Zero Position

With the (switched off) meter in horizontal position, the indicator needle (4) should cover the short green line (3) as you look straight down. If necessary, adjust the indicator needle to the zero line by turning the zero adjustment screw (28) on the underside of the LUNASIX F. The LUNASIX F is switched off if the measuring button (6) was not depressed and if the storage time (see page 6) has expired. (To be perfectly certain, you may also remove the batteries.)

It is sufficient to make this test at prolonged intervals.

3

### Testing and Replacing the Battery

The LUNASIX F operates on a 9V battery of the type IEC 6 F 22 or a rechargeable battery IEC 6 LF 22\*. It is being supplied by us with a commercially available Alkaline battery.

It is advisable to check the condition of the battery from time to time: check the battery by pushing and releasing the red measuring button (6) and then pushing in and holding the green battery test button (9). The meter needle must be within the green battery test zone marked "BATT" or to the right of it. Otherwise, the battery must be replaced.

To replace the battery, remove the cover of the battery chamber (30) on the underside of the LUNASIX F by sliding it off in the direction of the arrows.

After inserting the fresh battery make the test described above.



Test zero position

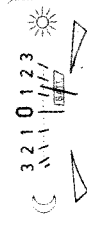

Battery test

\* these international standard designations correspond to the following brand names of batteries, (just some examples):

- Mallory MN 1604 (Alkali)
- Varta Super 438 or the rechargeable battery Varta 4022 for
- Dairmon no. 332 Novel 006 P (T) which a reasonably priced
- Dairmon no. 333 Novel 006 P battery charger is available
- Mallory M 1604 Maxell S-006 P (G)

4

## The Measurement Method

The LUNASIX F permits precise measurements of exposures of continuous light and the light of electronic flash units. Before you start measuring select the desired mode, either continuous light or flashes by means of the mode selector switch (36). The two possible measurements reflected light and incident light are being described on the pages 19 to 21. The LUNASIX F is well suited for those two alternative measuring methods and this for flashes too.

For measurement of exposures of continuous light see page 14, for measurement of flash light see page 15.

The LUNASIX F furthermore provides the capability of programming for extension factors and exposure compensation factors to give you direct read-outs without further calculations on your part (see page 7).

### Standard Setting

Measuring with the Standard Setting means that the red signal field is concealed by the black cover (16) and the white selector index (25) on the measuring button (6) is set at the square setting mark (26).

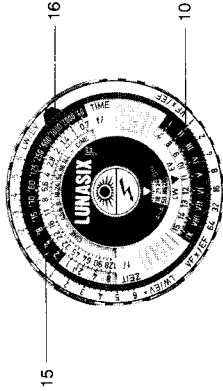

5

### Extended Measurement

You can override the electronic storage to make measurements which require more measuring time (for example: extensive contrast measurements). For extended measuring, depress the red measuring button (6) and lock it in place by turning it so that the white selector index (25) is set at the round setting mark (27). Your LUNASIX F now indicates the consecutive values of various measurements without storage, and the meter does not switch off automatically. Naturally, this also puts a heavier load on the battery.

To end the extensive measuring mode, depress the measuring button (6) and turn it to the left so that its white index (25) is set at the square setting mark (26) again. The value measured at the moment of releasing the button will be stored for approximately 30 seconds, after which the LUNASIX F switches itself off.

**Please don't forget – after completing extensive measurement – to turn the white index of the measuring button to the square setting mark (26) so that the LUNASIX F switches off after 30 seconds.**

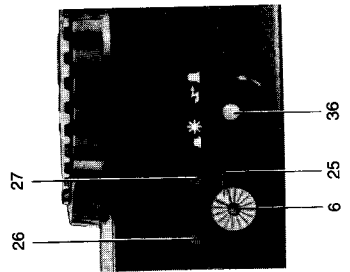

7

After the spherical diffuser (1) of the LUNASIX F has been set for the desired measuring method, depress the red measuring button (6). The LUNASIX F measures as long as this button is held down. When you release the button (6) the value measured (continuous light) at that moment will be automatically stored in the electronic memory of the LUNASIX F for approximately 30 sec. At the end of the storage time the LUNASIX F switches off automatically and the indicator needle (4) returns to the green zero line (3). Your measured reading remains set on the scales as long as you do not move the computer ring (24).

If you want to make a new measurement before the 30 seconds cycle is ended, simply depress the red measuring button (6); this clears the electronic memory and the new measurement is stored when you release the measuring button.

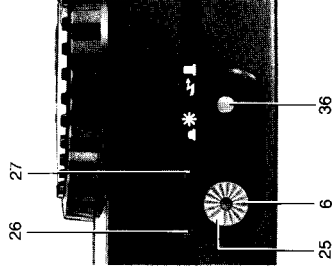

6

### Modification of Standard Exposure

Specific modification of the standard exposure may be desirable or necessary for a number of different reasons, e.g. when using filters (filter factor or f/stop factors may be given), when using cameras with bellows extension, using extension rings, working with macro lenses, or to compensate for reciprocity failure (see page 25), or when using the zone system (page 24).

You can set the applicable exposure value differences accurately on the outer scales (11) and (13): While holding the computer ring (24) rotate the inner setting ring (23) until one of the two white index lines (10) or (15) is set to the desired value. With such a setting the red signal under the cover (16) becomes visible to indicate, at a glance, that an extension factor or exposure value modification has been set on the scales.

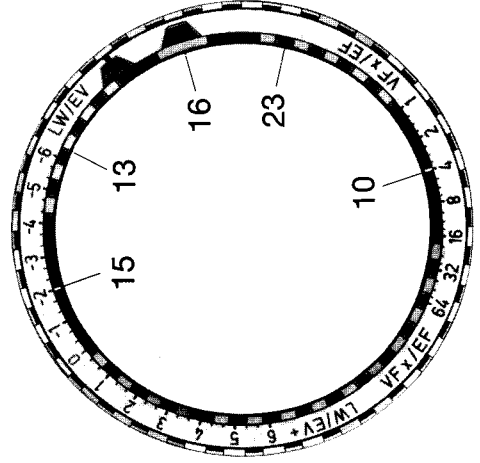

8

### Extension Factors

The scale for extension factors (11) is logarithmic. Intermediate factors indicated by scale lines are listed in the illustration.  
 Example: You want to use a filter marked "4x". Set the white index line (10) of scale (11) to "4", as shown in the illustration on page 9. The filter factor will now be considered automatically in your measurements with the LUNASIX F.

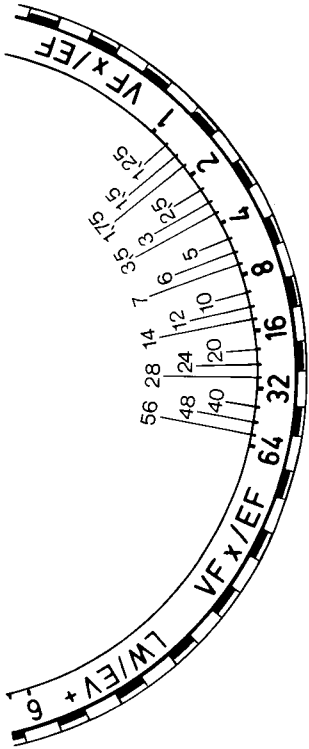

9

### Exposure Value Modification

You can set an exposure value modification with the white index line (15) on the green scale (13).  
 Example: If the filter is marked "-2EV" you set the white index line (15) of the green scale (13) to "-2". This factor will now be considered automatically.

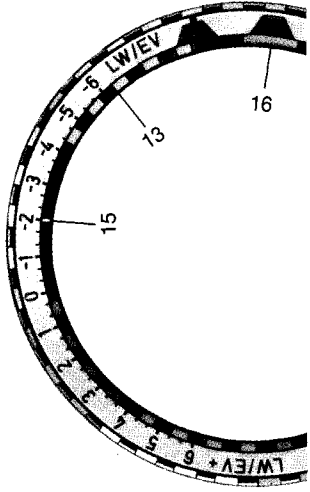

10

### Modification of Exposure Times

In the event that exposure time tolerances of your camera, or the sensitivity of your film require shorter exposure, you can also set the applicable values on the green scale (13), by increasing the exposure value.

Example: You have determined that, for optimal results,  $\frac{2}{3}$  less exposure is required. Set the white index line (15) at "+ $\frac{2}{3}$ " (higher exposure value). This factor is then automatically considered when you read the exposure scales.

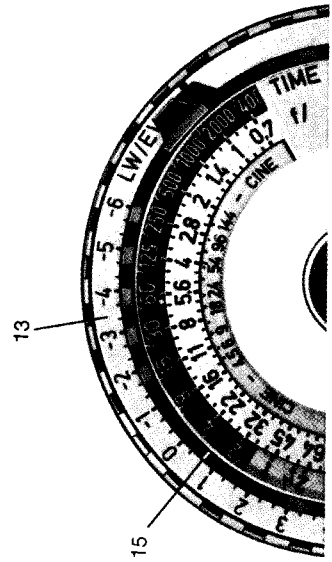

11

### Reading the Scales

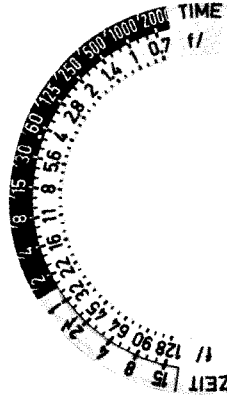

'2, '4, '8 are fractions of seconds.

Un-marked numerals 1, 2, 4 are full seconds.

1<sup>m</sup>, 2<sup>m</sup>, 4<sup>m</sup> etc. are minutes.

1<sup>h</sup>, 2<sup>h</sup>, etc. are hours.

The un-numbered white dot between '30 and '60 is the reading point for cinematographers (1/50 sec).

12

CINE frames per second (intermediate values)

**CINE f.p.s. and corresponding exposure times.**

**Note:** On some motion picture cameras, the exposure time at 18 f.p.s. is not 1/36 second.

**Please check instructions for your camera!**



### Extreme Film Sensitivities

When using exceptionally "fast" or "slow" films, the computer may, in extreme cases, show scale position as illustrated here. In these cases, exposure times are shown opposite small and large f-stops.

Here only the exposure times indicated in the upper half of the computer ring apply.

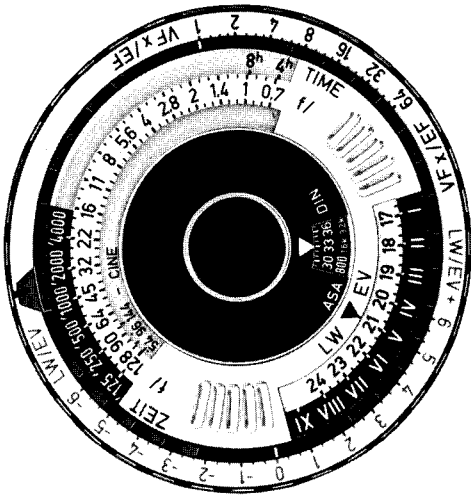

### Measuring Flashes

When used as flashmeter the LUNASIX F measures the flash intensities of commercially available flash units. The measuring time for flash is  $\frac{1}{60}$  s. Both measuring methods – incident light measurement and reflected light measurement (see page 19 and the following ones) can be used. Even under difficult light conditions the proper f-stop to be used will be reliably indicated. Do not depress the mode switch (36), thus it is set to the measuring mode for flashes (↗). Should the switch already be depressed, press down further thus releasing it again.

Shortly before starting the actual measurement, press the red measuring button (6) in order to clear the electronic memory.

After having operated the flash or multiple flashes, rotate the computer ring (24) until the indicator needle (4) is exactly over the "0" null line. Next read the proper f-stop opposite the red flash indicator (8) on scale (18), provided the red "0" on scale (13) will be between the two red triangles (7) on the meter face. If the red zero mark goes beyond either of the red triangles, the flash intensity is beyond the range of the meter. In that case refer to the following page "measuring range".



mode switch (36)

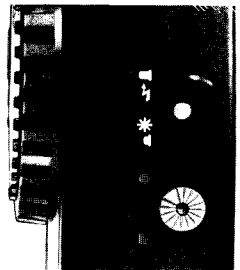

### Measuring Continuous Light

Depress the mode switch (36) so that it is set for measuring continuous light (↖).

Rotate the computer ring (24) until the indicator needle (4) is precisely over the "0" null line. The rotation direction indicators (5) tell you in which direction the computer ring (24) must be rotated. After nulling the needle the LUNASIX F gives you complete exposure information in combinations of f-stops and exposure times (scales 17 and 18) or – for motion picture cameras – f-stops (18) for a specific operating speed in frames per second (19) (please see also page 12).



mode switch (36)

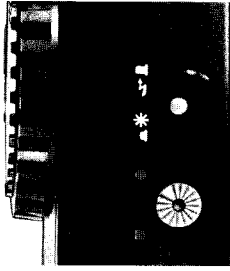

### Measuring Range

Accurate readings can be made in the range of 28.8 lux or 1.2 to 305 cds/m<sup>2</sup>. For a film speed setting of 21 DIN you can read e. g. f/stops from 2.8 + 2/3 to 4.5 + 2/3 at the flash indicator mark ↗ (8). This range is limited by the red triangular marks (7) on the meter face. After measuring and nulling the indicator needle on scale (2) the red zero mark (13) must remain between the two red triangles (7), otherwise the reading is not usable.

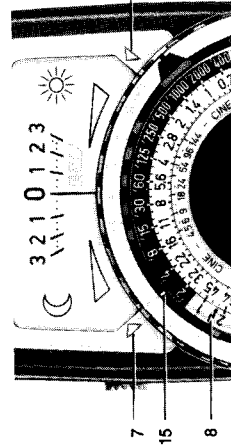

Upper limit of measuring range

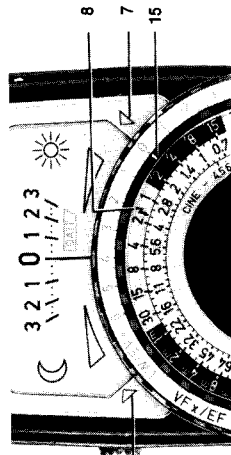

Lower limit of measuring range

If the red zero mark is outside that range, the f/stop opposite the flash indicator mark ↗ (8) must not be used. When past the right triangle the light level of the flash is too low. When past the left triangle, the light level of the flash is too high.

## Measuring in Extremely Bright Ambient Continuous Light

### Change of shutter speed setting

The circuitry of the LUNASIX F is designed to indicate f/stops which will produce correct overall exposure with a shutter speed of 1/60 or 1/50 sec. When, for any reason, a different shutter speed is used and if, at the same time, the ambient light is extremely bright, the indicated f/stop must be modified to compensate for variations caused by the change in shutter speed.

To determine, if compensation is required, two parallel measurements must be taken from the same position in the same direction and, of course, with the same film speed setting:

1. Measure the flash plus ambient continuous light, without pressing the mode switch (36) — either according to the incident light measuring method (diffusor placed in front of light entry aperture) or the reflected light method (without diffusor).
2. Press the mode switch (36) and measure the ambient continuous light only — in the same method used under 1. — either incident of reflected light. Next compare the f/stop readings obtained in the two measurements for a shutter speed of 1/60 or 1/50 sec. Any difference between the two readings calls for a f/stop modification as shown in the table below.

	Modification of f/stop setting, indicated by the LUNASIX F for camera shutter speed setting:			
	1/10 - 1/15	1/25 - 1/30	1/100 - 1/125	1/200 - 1/250
1	close down	close down	open up	open up
2	2/3	1/2	1/3	2/3
3	1/3	1/3	1/6	1/3
4	1/4	1/6	1/10	1/6
5	1/10	1/10	0	1/10
		0	0	0

Difference of readings obtained with flash measurement and ambient light in f/stops

## Reflected Light Measurement — Incident Light Measurement

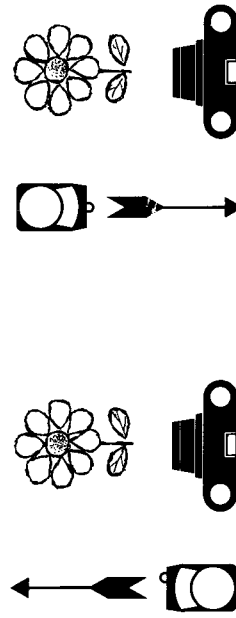

**Reflected Light Measurement.** Move the spherical diffusor (1) all the way to the right until it clicks into place. Point the LUNASIX F toward the subject, as indicated by the arrow in the illustration. The measuring angle is 30°.

**Incident Light Measurement.** Move the spherical diffusor (1) so that it clicks into place centered over the round window. Point the LUNASIX F from the subject toward the camera, as indicated by the arrow in the illustration. The measuring angle limitation is eliminated.

**Example:** The LUNASIX F indicated a reading of f/8 when measuring flash (flash and ambient continuous light). With the second measurement of the ambient light only f/5.6 was obtained for 1/60. Thus the difference between the two readings is 1 f/stop. If a shutter speed of 1/250 is to be used at the camera, the table shows that the lens must be opened by 2/3 stop from the reading given by the LUNASIX F for the flash measurement.

### Adding up Multiple Flashes

Occasionally, the light output from one flash of your equipment may not be enough to give you the f/stop desired. By repeatedly flashing with the shutter open, you can increase the total light output and work at smaller f/stops, e.g. for greater depth of field in interiors or other still subjects. When doing that multiple flash work, set the LUNASIX F immediately before measurement to "extended measurement". The LUNASIX F will accumulate the successive flashes and give a corresponding reading.

The adding up of the multiple flashes should not exceed a period of 2 minutes. In case it takes longer, you risk getting incorrect measuring results, because the storage time of the capacitor will be exceeded.

When adding up multiple flashes the measurement may have yielded the following values:

	f/stop at DIN 18
after the 1. flash	8
after the 2. flash	11
after the 3. flash	11/16
after the 4. flash	16

Any variations between the measured values of the individual flash impulses which you may discern in the process of adding up several flashes are due to the fact that electronic flash units do not necessarily have an identical lumens/second output from flash to flash. Permissible tolerances under existing German standards — DIN 19011 in effective light output range up to ± 20% which equals ± 1/2 f/stop.

In **reflected light measurement** (from camera toward subject), the LUNASIX F measures the light reflected by objects within a 30° angle. The LUNASIX F permits reading the reflected light also when measuring flashes. It is an easy to use method for uncomplicated cases. The resultant reading depends on the intensity of the illumination and on the reflecting properties of the scene. Thus, under identical illumination, the indicator needle will be deflected less by dark objects than by bright ones. The LUNASIX F adds the light and dark portions and indicates an average value. Therefore, if either dark or light areas predominate, better results will be obtained with the method of incident light measurement (page 21) or the use of the zone measuring system (page 24).

When photographing landscapes with a large share of bright sky it is advisable to hold the LUNASIX F slightly downward when measuring. Also close-up measuring is recommended. The small measuring angle of 30° permits carefully aimed measurements. You can "sample" various parts of the scene to determine how contrasty or balanced the subject is in its overall brightness (see also page 23 "Measuring Contrasts").

With the TELE attachment you can reduce the measuring angle of the LUNASIX F to 15° or 7.5° (see page 28).

## Comparison Tables on the Back of the LUNASIX F

### Light Intensities in lux and footcandles

The table (29) on the back of the LUNASIX F shows the approximate values of light intensity in lux (lx) or footcandles (fc) corresponding to the Exposure Values (EV) (22) obtained by the **incident light measuring method** and continuous light mode (☉) with the film speed set at 18 DIN/ASA 50. The LUNASIX F cannot be used as a precision luxmeter, because precise light intensity measurements can only be made by means of a flat light sensitive surface. The spherical diffusor of the LUNASIX F exposure meter is primarily designed for collecting the photographically effective light. Photographic subjects are usually three dimensional and receive light from many different directions (sun, sky, reflections from buildings, trees, ground, etc.)

### Luminance in candela per square meter

**Reflected light measurement** indicates the light reflected by the subject i. e. luminances. The measured value indicates how much light the area (m<sup>2</sup>) radiates. The unit value is "candela per square meter" (cd/m<sup>2</sup>).

For comparison purposes between the two measuring methods: the measured values for reflected light measurement expressed in cd/m<sup>2</sup> are approximately 1/24 of the lux values obtained in incident light measurement. Examples:

Exposure values (EV) at 18 DIN	-2	-1	0
lx (incident light measurement)	1.4	2.8	5.5
cd/m <sup>2</sup> (reflected light measurement)	0.055	0.11	0.22

22

## Measuring Contrast

### Scene brightness range

The LUNASIX F is ideally suited for this type of measurement because of its null meter design and a scale range over six f/stops which are subdivided in 1/3 f-stops. Contrasts can be measured quickly and without any problem at all. Without further adjustment of the calculator you just watch the needle movement when taking readings from highlight to shadow areas and read the variance of these areas in f/stops on the scale. Furthermore the ratio of different brightnesses when compared with each other or when compared with a chosen reference point will be indicated directly. Also the contrasts in lighting being of particular importance for the creative composition of the picture can easily be determined.

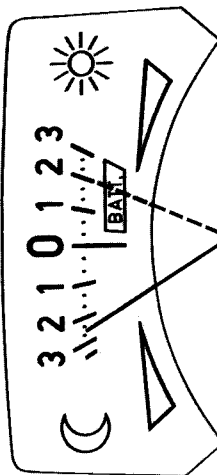

23

## Zone System

There are times when the lighting range cannot be brought within the acceptance limits of the film and paper contrast ranges. When these situations arise, the zone system can be used. In doing so, detail can be recorded which would otherwise be lost. A complete discussion of this technique is far beyond this instruction booklet.

The LUNASIX F is well suited for using the zone system because of its measuring principle. For this purpose, the computer ring (24) of the LUNASIX F shows the figures I to IX (34). Based on the important parts of your subject (zone V when the indicator needle (4) is over the "0" null line) the range from high-light to shadows in the scene are measured. Their variance from the middle zone determines the amount of exposure correction and processing modification that is needed.

Depending on the nature of the contrast range and also in case of extreme contrast the standard exposure is not to be applied, but a modified exposure must be used according to the contrast range (sometimes 1 to 2 stops) in order to receive proper exposure for the most important high-light and shadow parts. This may entail that some detail in the less important areas will be lost.

24

In **incident light measurement** (from subject toward camera) the LUNASIX F measures all the light falling on that part of the subject which faces the camera. The resulting measurement is primarily determined by the illumination while the reflecting properties of the scene can have only a minor influence on the measuring result. The method of incident light measurement is generally preferable, and you can prove with your LUNASIX F that this method leads more assuredly to good exposures under difficult conditions — such as contrasty subjects — than reflected light measurement.

With inaccessible subjects, take the incident light measurement **at a substitute spot** which receives the same illumination as the subject. Instead of pointing the LUNASIX F toward the camera, point it parallel to an imaginary line from subject to camera.

21

## Reciprocity Effect

Photography under poor light conditions may require exceptionally long exposure times. In such circumstances, films of all types and makes are subject to a phenomenon called "reciprocity effect". Measured exposure times must be increased to avoid underexposure. Films of various types and makes react differently to such longer exposures; therefore the reciprocity effect was not considered in the computer scales of the LUNASIX F.

The reciprocity effect may cause shifts in the colour balance of all colour films. They can be compensated by using correction filters.

Some film types come provided with special data sheets containing instructions for very long exposures. In other instances it is recommendable to contact major colour processing laboratories or film manufacturers direct asking them for specific data.

25

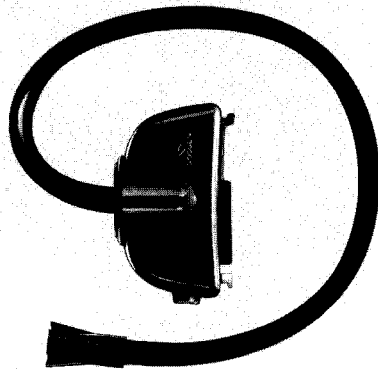

### MEASURING PROBE

This attachment is suitable for selective (spot) measurements at otherwise inaccessible locations, for micro and macro photography, for determining the contrast of negatives and for densitometric measurements.

Furthermore it can be used for selective measurements on ground glasses at ambient light.

Each accessory is supplied with complete instructions for its specific applications.

27

## The LUNASIX F System

Optional attachments available for the LUNASIX F. By means of those attachments the capability of the LUNASIX F can be expanded for use in the most diverse special fields of photography, thus helping you to master even most difficult problems. It is of particular interest that the attachments can be used both when measuring ambient light and also when measuring flashes.

1. The MEASURING PROBE is suitable for contrast and exposure measurements at small objects (macro photography), on standard grey cards, for spot and densitometric measurements.

For selective ambient light measurements on camera ground glasses.

2. The TELE attachment reduces the measuring angle from 30° to 15° or 7.5°.
3. The MICRO attachment provides precise measuring in photomicrography.
4. The LAB attachment ensures correct exposure when enlarging.
5. The REPRO attachment facilitates measuring when in copying work.

26

### TELE attachment

The TELE reduces the measuring angle to 15° or 7.5°. The LUNASIX F together with the TELE is thus ideally suited for selective readings of various important parts of the scene or subject and for measuring contrasts.

In the LUNASIX F the exposure correction scale must be adjusted to give you direct readings, while compensating the difference in reading due to the attachment.

The EV + section of the scale (13) is used. For the corrections, set the white index line (15)

for continuous light

with measuring angle 15° to "(+)" 1"

with measuring angle 7.5° to "(+)" 3"

for flashes

with measuring angle 15° to "(+)" 1"

with measuring angle 7.5° to "(+)" 2"

Readings are then taken normally.

The viewfinder will show you which parts of the subject you are actually measuring.

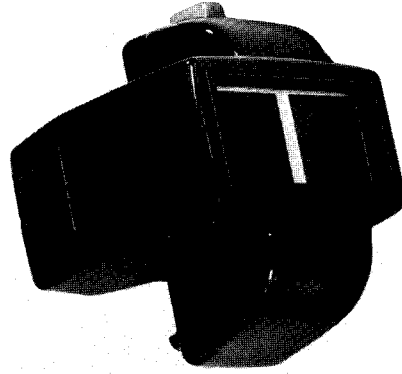

Each accessory is supplied with complete instructions for its specific applications.

28



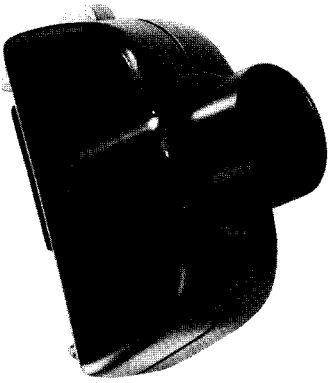

#### **MICRO attachment**

The LUNASIX F together with the micro attachment allows convenient and reliable exposure measurements when taking photographs. The attachment fits the ocular tube of all microscope types.

Each accessory is supplied with complete instructions for its specific applications.

29



#### **LAB attachment**

The LAB attachment will eliminate guesswork in darkroom printing and enlarging. It determines contrast range and correct exposure time.

Each accessory is supplied with complete instructions for its specific applications.

30

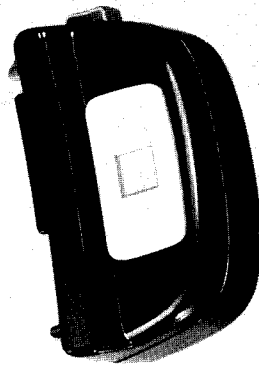

#### **REPRO attachment**

With the REPRO attachment on the LUNASIX F it is possible to obtain exposure values of flat copy such as painting, documents and photographic prints.

Each accessory is supplied with complete instructions for its specific applications.

31

If repair or adjustment should ever become necessary, send your LUNASIX F, carefully packed, to:

GOSSEN GMBH  
Servicestelle B  
Nägelsbachstraße 25  
D-8520 Erlangen

or to the GOSSEN agency in your own country.

To expedite handling please send your LUNASIX F only — without case and neck strap or other accessories.

32